



SOH-A2

Sulfur Dioxide Hydrogen Sulfide



Introduction

Personal gas safety monitors can be found in almost every industry, with the requirement for multiple gas detection becoming commonplace.

Sulfur gases are toxic with a complex chemistry. Measuring both SO₂ and H₂S provides the information for separating the corrosive gases, but with different toxicologies.

Specification Sulfur Dioxide Channel

PERFORMANCE	Sensitivity	nA/ppm in 10ppm SO ₂	140 to 250
	Response time	t ₉₀ (s) from zero to 10ppm SO ₂	< 15
	Zero current	ppm equivalent in zero air	< ± 0.2
	Resolution	rms noise (ppm equivalent)	< 0.2
	Range	ppm SO ₂ limit of performance warranty	20
	Linearity	ppm error at full scale, linear at zero and 10 ppm SO ₂	< ±2
	Overgas limit	ppm maximum SO ₂ for stable response to gas pulse	50

LIFETIME	Zero drift	ppm equivalent change/year in lab air	< 0.5
	Sensitivity drift	% change/year in lab air, monthly test	< 6
	Operating life	months until 80% original signal (24 month warranted)	24

ENVIRONMENTAL	Sensitivity @ -20°C	% (output @ -20°C/output @ 20°C) @ 10ppm SO ₂	90 to 100
	Sensitivity @ 50°C	% (output @ 50°C/output @ 20°C) @ 10ppm SO ₂	80 to 100
	Zero @ -20°C	ppm equivalent change from 20°C	-0.2 to 0.2
	Zero @ 50°C	ppm equivalent change from 20°C	0.2 to 0.8

CROSS SENSITIVITY	Filter capacity ppm hours of Hydrogen Sulfide		nd
	H ₂ S sensitivity	% measured gas @ 20ppm H ₂ S	< 15
	NO ₂ sensitivity	% measured gas @ 10ppm NO ₂	< -150
	Cl ₂ sensitivity	% measured gas @ 10ppm Cl ₂	< -50
	NO sensitivity	% measured gas @ 50ppm NO	< 50
	CO sensitivity	% measured gas @ 400ppm CO	< 1
	H ₂ sensitivity	% measured gas @ 400ppm H ₂ @ 20°C	< 1
	C ₂ H ₄ sensitivity	% measured gas @ 400ppm C ₂ H ₄	< 40
	NH ₃ sensitivity	% measured gas @ 20ppm NH ₃	< 1

KEY SPECIFICATIONS

Temperature range	°C	-30 to 50
Pressure range	kPa	80 to 120
Humidity range	%rh continuous (see note below)	15 to 90
Storage period	months @ 3 to 20°C (stored in sealed pot)	6
Load resistor	Ω (recommended)	10 to 47
Weight	g	< 6

Note: Above 85% rh and 40°C a maximum continuous exposure period of 10 days is warranted. Where such exposure occurs the sensor will recover normal electrolyte volumes, when allowed to rest at lower %rh and temperature levels for several days.



Performance Data Sulfur Dioxide Channel



Technical Specification

Figure 1 SO₂ Channel response to 20ppm SO₂

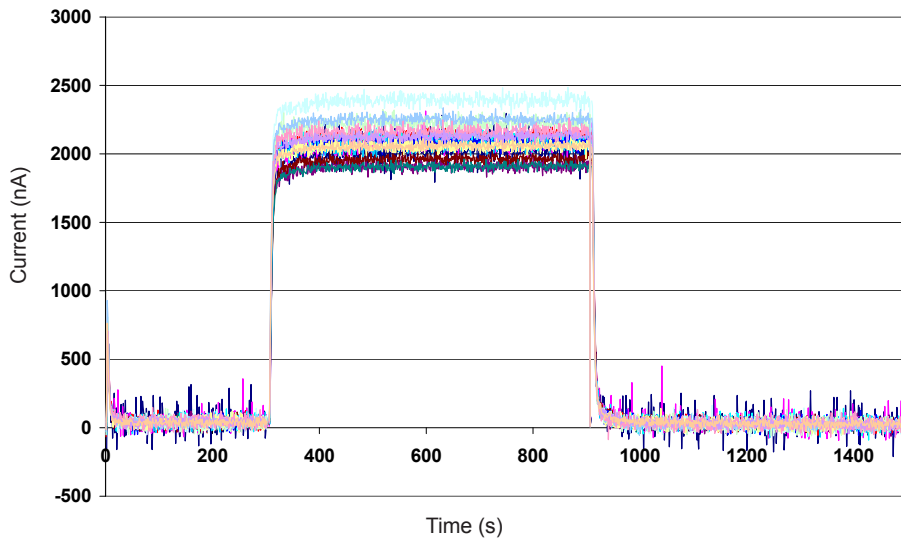

Figure 1 shows transient response to breathing on the sensor: combined temperature and humidity transient response

Figure 2 SO₂ Channel Sensitivity Temperature Dependence

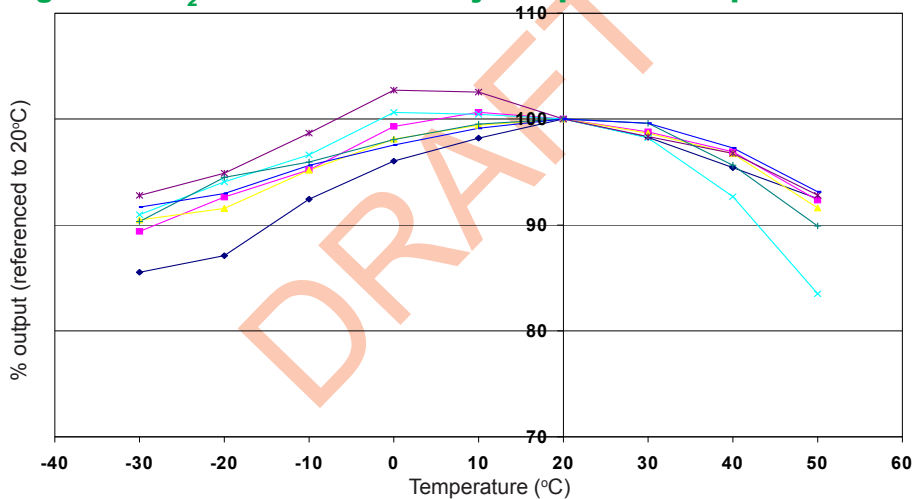

Figure 2 shows the % variation in sensitivity caused by changes in temperature.

The data is taken from a typical batch of sensors.

Figure 3 Channel Zero Temperature Dependence

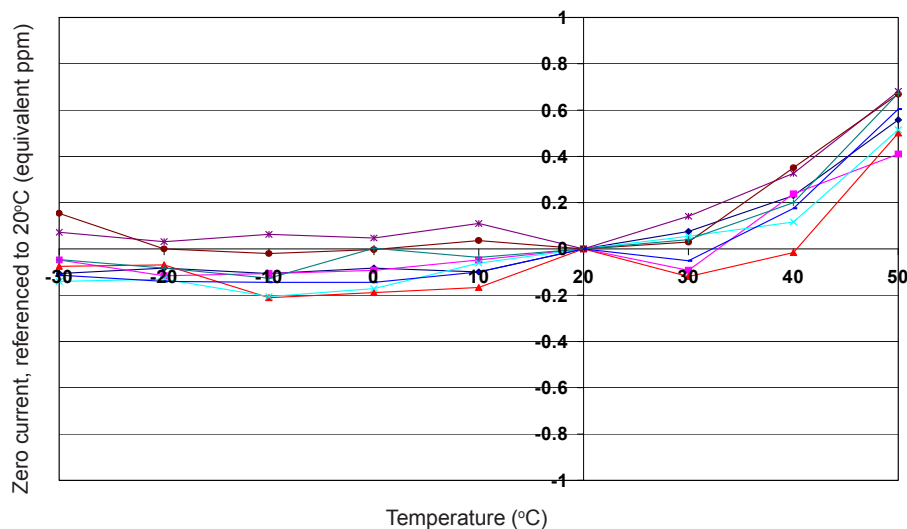

Figure 3 shows the variation in zero output caused by changes in temperature, expressed as ppm gas equivalent, referenced to the zero at 20°C.

This data is taken from a typical batch of sensors.



2sense

SOH-A2 Specification contd.



Figure 4 Schematic Diagram

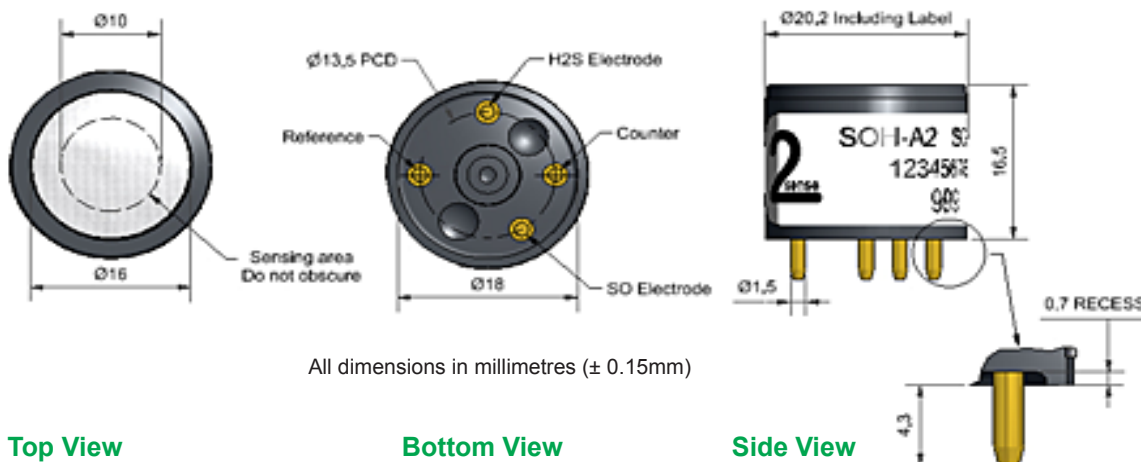

Technical Specification

Specification Hydrogen Sulfide Channel

PERFORMANCE	Sensitivity	nA/ppm in 20ppm H ₂ S	450 to 900
	Response time	t ₉₀ (s) from zero to 20ppm H ₂ S @ 20°C	< 25
	Zero current	ppm equivalent in zero air	± 0.25
	Resolution	rms noise (ppm equivalent)	< 0.1
	Range	ppm H ₂ S limit of performance warranty	100
	Linearity	ppm error at full scale, linear at zero and 20ppm H ₂ S	< ± 5
	Overgas limit	maximum ppm H ₂ S for stable response to gas pulse	200
LIFETIME	Zero drift	ppm equivalent change/year in lab air	< 0.1
	Sensitivity drift	% change/year in lab air, monthly test	< 2
	Operating life	months until 80% original signal (24 month warranted)	24
ENVIRONMENTAL	Sensitivity @ -20°C	% (output @ -20°C/output @ 20°C) @ 20ppm H ₂ S	75 to 90
	Sensitivity @ 50°C	% (output @ 50°C/output @ 20°C) @ 20ppm H ₂ S	100 to 110
	Zero @ -20°C	ppm equivalent change from 20°C	± 0.2
	Zero @ 50°C	ppm equivalent change from 20°C	± 0.2
CROSS SENSITIVITY	Filter capacity	ppm.hrs of SO ₂	nd
	NO ₂ sensitivity	% measured gas @ 10ppm NO ₂	< -25
	Cl ₂ sensitivity	% measured gas @ 10ppm Cl ₂	< -20
	NO sensitivity	% measured gas @ 50ppm NO	< 15
	SO ₂ sensitivity	% measured gas @ 10ppm SO ₂	< 30
	CO sensitivity	% measured gas @ 400ppm CO	< 1.5
	H ₂ sensitivity	% measured gas @ 400ppm H ₂	< 0.2
	C ₂ H ₄ sensitivity	% measured gas @ 400ppm C ₂ H ₄	< 0.2
NH ₃ sensitivity	% measured gas @ 20ppm NH ₃	< ± 0.5	

Note: Above 85% rh and 40°C a maximum continuous exposure period of 10 days is warranted. Where such exposure occurs the sensor will recover normal electrolyte volumes, when allowed to rest at lower %rh and temperature levels for several days.



At the end of the product's life, do not dispose of any electronic sensor, component or instrument in the domestic waste, but contact the instrument manufacturer, Alphasense or its distributor for disposal instructions.

NOTE: all sensors are tested at ambient environmental conditions, with 47 ohm load resistor, unless otherwise stated. As applications of use are outside our control, the information provided is given without legal responsibility. Customers should test under their own conditions, to ensure that the sensors are suitable for their own requirements.



Performance Data Hydrogen Sulfide Channel

Technical Specification

Figure 5 H₂S Channel Response to 25ppm H₂S

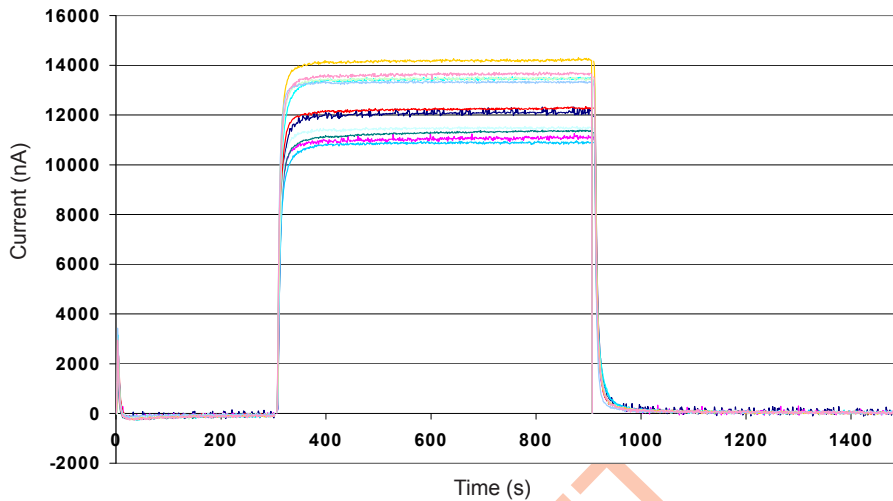

Figure 5 shows transient response to breathing on the sensor: combined temperature and humidity transient response

Figure 6 H₂S Channel Sensitivity Temperature Dependence

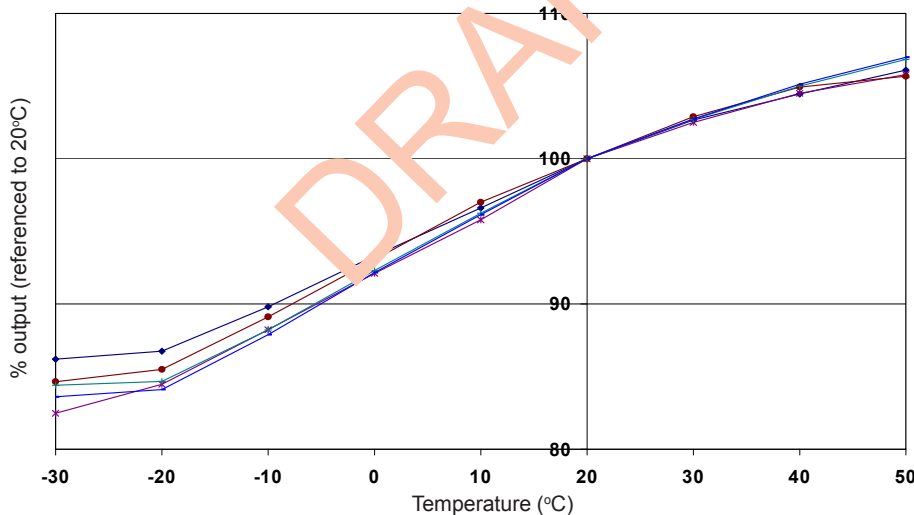

Figure 6 shows the % variation in sensitivity caused by changes in temperature.

The data is taken from a typical batch of sensors.

Figure 7 H₂S Channel Zero Temperature Dependence

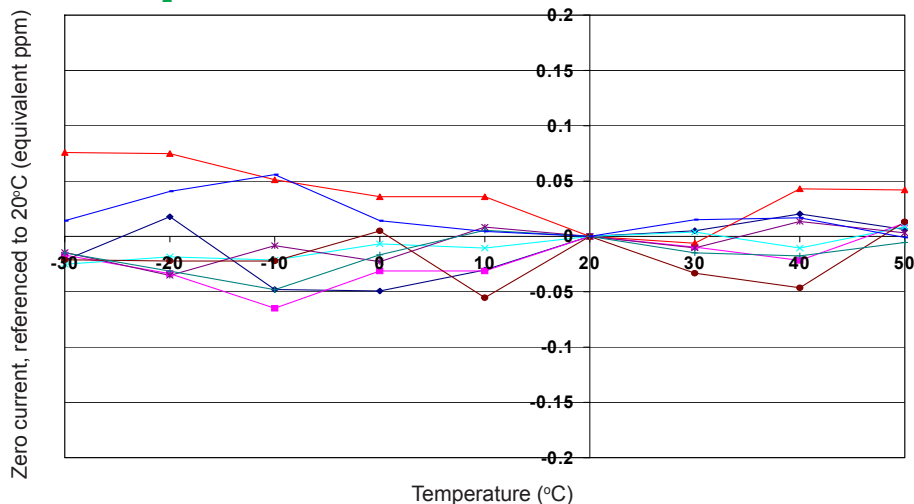

Figure 7 shows the variation in zero output caused by changes in temperature, expressed as ppm gas equivalent, referenced to the zero at 20°C.

This data is taken from a typical batch of sensors.

For further information on the performance of this sensor, on other sensors in the range or any other subject, please contact Alphasense Ltd. For Application Notes visit "www.alphasense.com".

In the interest of continued product improvement, we reserve the right to change design features and specifications without prior notification. The data contained in this document is for guidance only. Alphasense Ltd accepts no liability for any consequential losses, injury or damage resulting from the use of this document or the information contained within. (©ALPHASENSE LTD) Doc. Ref. SOH-A2/NOV15